



IMAGING TABLES & ACCESSORIES

- C-Arm Tables
- Urology & Lithotripsy Tables
- Spine Positioning System

made in the USA
with US & imported parts



PRODUCTS AT A GLANCE



CFPM400 #81772 Integrated
#81808 Rectangular

CFPM401 #81802 Integrated
#81809 Rectangular

Page 4-5

FEATURES

Integrated Headrest Carbon Fiber Top: 22" (56cm) wide x 84" (214cm) long
Rectangular Carbon Fiber Top: 24" (61cm) wide x 80" (203cm) long
Hand Control (all functions)
Weight Capacity: 500lb (227kg)
2" (3cm) Radiolucent Table Top Pad
4" (10cm) Casters
Crescent face rest pad (included with Integrated Headrest Top)
Patient Restraint Straps (2)
Warranty: 3 years parts, 2 years labor
FDA listed, CE marked, cETLus listed, CB Certificate

MOVEMENTS

CFPM400

Motion 1.....height range 26" - 43" (66-109cm)
Motion 2.....Trendelenburg tilt +15°/-11°
Motion 3..... longitudinal travel 10" (25cm)
Motion 4.....lateral tilt ±15°

CFPM401

Motion 1.....height range 26" - 44" (66-112cm)
Motion 2.....Trendelenburg tilt +15°/-12°
Motion 3..... longitudinal travel 10" (25cm)
Motion 4.....8" (20cm), ±4" lateral travel



CFPM302 #84530 Integrated
#84532 Rectangular

Page 6-7

FEATURES

Integrated Headrest Carbon Fiber Top: 22" (56cm) wide x 84" (213cm) long
Rectangular Carbon Fiber Top: 24" (61cm) wide x 80" (203cm) long
Hand Control (all functions)
Weight Capacity: 500lb (227kg)
2" (3cm) Radiolucent Table Top Pad
4" (10cm) Casters
Crescent face rest pad (included with Integrated Headrest Top)
Patient Restraint Straps (2)
Warranty: 3 years parts, 2 years labor
FDA listed, CE marked, cETLus listed, CB Certificate

MOVEMENTS

Motion 1.....height range 25" - 43" (64-109cm)
Motion 2.....longitudinal travel 10" (25cm)
Motion 3..... lateral tilt ±15°



CFPM300 #81803 Integrated
#81810 Rectangular

CFPM301 #81804 Integrated
#81811 Rectangular

Page 8-9

FEATURES

Integrated Headrest Carbon Fiber Top: 22" (56cm) wide x 84" (214cm) long
Rectangular Carbon Fiber Top: 24" (61cm) wide x 80" (203cm) long
Hand Control (all functions)
Weight Capacity: 500lb (227kg)
2" (3cm) Radiolucent Table Top Pad
4" (10cm) Casters
Crescent face rest pad (included with Integrated Headrest Top)
Patient Restraint Straps (2)
Warranty: 3 years parts, 2 years labor
FDA listed, CE marked, cETLus listed, CB Certificate

MOVEMENTS

CFPM300

Motion 1.....height range 26" - 43" (66-109cm)
Motion 2.....Trendelenburg tilt +15°/-11°
Motion 3.....lateral tilt ±15°

CFPM301

Motion 1.....height range 25" - 43" (64-109cm)
Motion 2.....Trendelenburg tilt +15°/-11°
Motion 3..... longitudinal travel 10" (25cm)



CFPMB301 #81812 Rectangular

Page 10-11

FEATURES (BARIATRIC IMAGING TABLE)

Rectangular Carbon Fiber Top: 24" (61cm) wide x 80" (203cm) long
Hand Control (all functions)
Weight Capacity: 750lb (340kg)
2" (3cm) Radiolucent Table Top Pad
Heavy Duty 5" (13cm) Casters
Patient Restraint Straps (2)
Warranty: 3 years parts, 2 years labor
FDA listed, CE marked, cETLus listed, CB Certificate

MOVEMENTS

Motion 1.....height range 26" - 44" (66-112cm)
Motion 2.....Trendelenburg tilt +15°/-11°
Motion 3..... longitudinal travel 10" (25cm)



CFPM200 #84522 Integrated
#84524 Rectangular

CFPM201 #84526 Integrated
#84528 Rectangular

Page 12-13

FEATURES

Integrated Headrest Carbon Fiber Top: 22" (56cm) wide x 84" (214cm) long
Rectangular Carbon Fiber Top: 24" (61cm) wide x 80" (203cm) long
Hand Control (all functions)
Weight Capacity: 500lb (227kg)
2" (3cm) Radiolucent Table Top Pad
4" (10cm) Casters
Crescent face rest pad (included with Integrated Headrest Top)
Patient Restraint Straps (2)
Warranty: 3 years parts, 2 years labor
FDA listed, CE marked, cETLus listed, CB Certificate

MOVEMENTS

CFPM200

Motion 1.....height range 25" - 43" (64-109cm)
Motion 2.....lateral tilt ±15°

CFPM201

Motion 1.....height range 25" - 42" (64-107cm)
Motion 2.....Trendelenburg tilt +15°/-11°

PRODUCTS AT A GLANCE



CFPM100 #81805 Integrated #81813 Rectangular

FEATURES

Integrated Headrest Carbon Fiber Top: 22" (56cm) wide x 84" (213cm) long
 Rectangular Carbon Fiber Top: 24" (61cm) wide x 80" (203cm) long
 Foot Control
 Weight Capacity: 500lb (227kg)
 2" (3cm) Radiolucent Table Top Pad
 4" (10cm) Casters
 Crescent face rest pad (included with Integrated Headrest Top)
 Patient Restraint Straps (2)
 Warranty: 3 years parts, 2 years labor
 FDA listed, CE marked, cETLus listed, CB Certificate

MOVEMENTS

Motion 1....height range 22" - 40" (56-102cm)



DTPM300 # 81806 Rectangular

FEATURES

Rectangular Polycarbonate Top: 24" (61cm) wide x 78" (198cm) long
 Hand Control (Height, Trendelenburg/Reverse)
 Foot Control (Height)
 Weight Capacity: 450 lb (204kg)
 2" (5cm) Radiolucent Table Top Pad
 4" (10cm) Casters
 Patient Restraint Straps (2)
 Warranty: 3 years parts, 2 years labor
 FDA listed, CE marked, cETLus listed, CB Certificate

MOVEMENTS

Motion 1....height range 24" - 40" (61-102cm)
 Motion 2.....manual travel top 23" (58cm)
 Motion 3.....Trendelenburg tilt $\pm 14^\circ$



CFUR301 #83868 CFUR401 #83867

FEATURES (UROLOGY)

Carbon Fiber Top: 23" (58cm) wide x 47" (119cm) long
 Hand and Foot Control (all functions)
 Weight Capacity: 500lb (227kg)
 2" (5cm) Radiolucent Table Top Pad
 4" (10cm) Casters
 Patient Restraint Straps (2)
 Radiolucent Lateral Extensions (2) attach to T-rail
 Radiolucent Patient Transfer Extension (1) attach to end of table
 T-rail - full length of top
 Urology Bag Hoop (bag not included)
 Warranty: 3 years parts, 2 years labor
 FDA listed, CE marked, cETLus listed, CB Certificate

MOVEMENTS

CFUR301

Motion 1....height range 26" - 44" (66-111cm)
 Motion 2.....Trendelenburg tilt $+15^\circ/-11^\circ$
 Motion 3.....longitudinal travel 10" (25cm)

CFUR401

Motion 1....height range 26" - 44" (66-111cm)
 Motion 2.....Trendelenburg tilt $+15^\circ/-11^\circ$
 Motion 3.....longitudinal travel 10" (25cm)
 Motion 4.....lateral travel 8" (20cm)

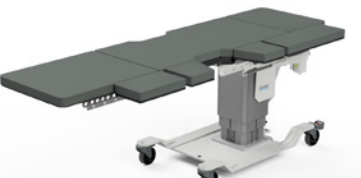

CFLU401 #82014

FEATURES (LITHOTRIPSY/UROLOGY)

Carbon Fiber Top: 23" (58cm) wide x 47" (119cm) long
 Hand and Foot Control (all functions)
 Weight Capacity: 500lb (227kg)
 2" (5cm) Radiolucent Table Top Pad
 5" (13cm) Casters
 Patient Restraint Straps (2)
 Radiolucent Lateral Extensions (4) attach to T-rail
 Radiolucent Patient Transfer Extensions (2) attach to end of table
 T-rail - full length of top (except in cut-out areas)
 Urology Bag Hoop (bag not included)
 Warranty: 3 years parts, 2 years labor
 FDA listed, CE marked, cETLus listed, CB Certificate

MOVEMENTS

Motion 1....height range 27" - 45" (69-114cm)
 Motion 2.....Trendelenburg tilt $+15^\circ/-11^\circ$
 Motion 3.....longitudinal travel 10" (25cm)
 Motion 4.....lateral travel 8" (20cm)



Oakworks Imaging Tables • Motions At-A-Glance



Trendelenburg Tilt



Longitudinal Travel



Lateral Tilt



Lateral Travel

Table Type	Height Range *without pad	Weight Rating	Trendelenburg Tilt	Longitudinal Travel	Lateral Tilt	Lateral Travel
CFPM100	22"-40" (56-102cm)	500lbs	n/a	n/a	n/a	n/a
CFPM200	25"-43" (64-109cm)	500lbs	n/a	n/a	±15°	n/a
CFPM201	25"-42" (64-107cm)	500lbs	+15°/-11°	n/a	n/a	n/a
CFPM300	26"-43" (66-109cm)	500lbs	+15°/-11°	n/a	±15°	n/a
CFPM301	25"-43" (64-109cm)	500lbs	+15°/-11°	10" (25cm)	n/a	n/a
CFPMB301	26-44" (66-112cm)	750lbs	+15°/-11°	10" (25cm)	n/a	n/a
CFPM302	25"-43" (64-109cm)	500lbs	n/a	10" (25cm)	±15°	n/a
CFPM400	26"-43" (66-109cm)	500lbs	+15°/-11°	10" (25cm)	±15°	n/a
CFPM401	26"-44" (66-112cm)	500lbs	+15°/-11°	10" (25cm)	n/a	8" (20cm) ±4"
DTPM300	24"-40" (61-102cm)	450lbs	+14°/-14°	23" (58cm) (manual)	n/a	n/a

Your Choice of Table Tops - 56" Metal Free Imaging Space

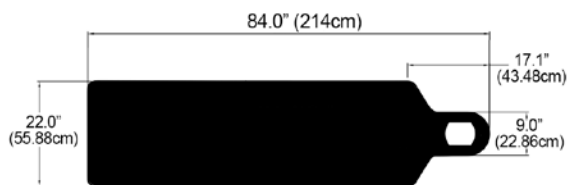

INTEGRATED HEADREST

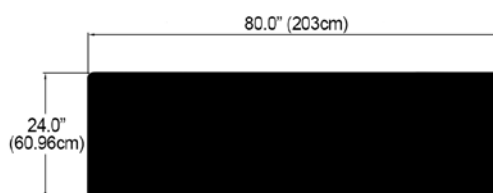

RECTANGULAR

CFPM400 & CFPM401 Imaging Tables



Integrated Headrest Table

Oakworks Imaging Tables have a large height range helping to create safe patient transfers while allowing doctors to stand comfortably. Our large lifting column is very rigid, ensuring rock solid support for fast imaging and procedures.

Available with an integrated headrest or rectangle top.

Motions

- Motion 1 - Height Range 26" - 43" (CFPM400)
- Motion 1 - Height Range 26" - 44" (CFPM401)
- Motion 2 - Trendelenburg Tilt +15/-11°
- Motion 3 - Longitudinal Travel 10"
- Motion 4 - Lateral Tilt $\pm 15^\circ$ (CFPM400)
- Motion 4 - Lateral Travel 8", ± 4 " (CFPM401)

Features

- Choice of integrated headrest or rectangular carbon fiber tops with 56" of metal free imaging
- 2" Radiolucent Comfort Foam[®] table top pad
- Warranty is 3 years parts and 2 years labor

SPECIFICATIONS

- Cost Effective 4 Movement Table
- Large Adjustable Height Range 26" - 43" (CFPM400), 26" - 44" (CFPM401)
- 56" Metal Free Imaging Space
- 500 lb Patient Weight Capacity
- Warranty: 3 years parts, 2 years labor



Rectangular Top Table

CFPM400 #81772 Integrated #81808 Rectangular **CFPM401** #81802 Integrated #81809 Rectangular

INCLUDED FEATURES	
Carbon Fiber Top 56" Metal free imaging space	Integrated Headrest 22" (56cm) wide x 84" (214cm) long Rectangular 24" (61cm) wide x 80" (203cm) long
CFPM400 MOVEMENTS	
Motion 1	Electric Height Range 26" - 43" (66-109cm) (without pad)
Motion 2	Electric Trendelenburg tilt +15°/-11°
Motion 3	Electric Longitudinal travel 10" (25cm)
Motion 4	Electric Lateral tilt ±15°
CFPM401 MOVEMENTS	
Motion 1	Electric Height Range 26" - 44" (66-112cm) (without pad)
Motion 2	Electric Trendelenburg tilt +15°/-12°
Motion 3	Electric Longitudinal travel 10" (25cm)
Motion 4	Electric Lateral travel 8" (20cm), ±4"
Controls	All functions hand control
Weight Capacity	500 lb (227kg)
Product Weight	475 lb (216kg)
Included Features	2" (5cm) Radiolucent Comfort Foam™ table top pad, 4" (10cm) locking casters, Crescent face rest pad (included with integrated headrest top), patient restraint straps (2)
Warranty	3 years parts, 2 years labor
Safety Listings	FDA listed, CE marked, cETLus listed, CB Certificate

OPTIONS <i>must be ordered with table.</i>	
5" (13cm) casters	Recommended for mobile service providers
Foot Control	All functions control
Non-USA electrical systems	Please inquire

ACCESSORIES <i>order any time.</i>		#
Arm Hammock	Use with Integrated Headrest Top	48751
Carbon Fiber Arm Board (6" wide)	180° Articulation	83575
Fluoro Extender	Polycarbonate	33975
Interventional Supine Pillow System	Contoured pad and support wedge pad	81821
Spine Positioning System II	8 piece system	81819
T-rail Clamp	6" (15cm) long rail	63336

ACCESSORIES

SPINE POSITIONING SYSTEM II

Radiolucency & adjustability for ideal cervical, thoracic & lumbar visualization. Minimize unwanted movement & reduce procedure time.



ARM HAMMOCK

This unique product will comfortably & easily support your patient's arms when prone. Easily attached to the Integrated Head Rest table top.



SINGLE CARBON FIBER ARM BOARD

Fully radiolucent with a 180° range of motion, the arm board requires no mounting or attachment hardware and simply slides under the table top pad. It can be used on any fluoroscopy table & will support arms and feet in a variety of positioning configurations.



FLUORO EXTENDER

Made of radiolucent, polycarbonate material, it's organic shape is conducive to a variety of table placement applications. 30" long x 23.5" wide x 1/4" thick



6" ADJUSTABLE T-RAIL CLAMP

The adjustable T-rail clamp can be positioned along the grooved table top edge. Clamp is also removable.



5" CASTER (OPTIONAL)

Recommended for mobile service providers.





CFPM302 Imaging Table

Oakworks Imaging Tables have a large height range helping to create safe patient transfers while allowing doctors to stand comfortably. Our large lifting column is very rigid, ensuring rock solid support for fast imaging and procedures.



Integrated Headrest Table

Motions

- Motion 1 - Height Range 25" - 43"
- Motion 2 - Longitudinal Travel 10"
- Motion 3 - Lateral Tilt $\pm 15^\circ$

Features

- Choice of integrated headrest or rectangular carbon fiber tops with 56" of metal free imaging
- 2" Radiolucent Comfort Foam[®] table top pad
- Warranty is 3 years parts and 2 years labor

SPECIFICATIONS

- Large Adjustable Height Range 25" - 43"
- 56" Metal Free Imaging Space
- Cost Effective 3 Movement Table
- 500 lb Patient Weight Capacity
- Warranty: 3 years parts, 2 years labor

CFPM302 #84530 Integrated #84532 Rectangular

INCLUDED FEATURES

Carbon Fiber Top 56" Metal free imaging space	Integrated Headrest 22" (56cm) wide x 84" (214cm) long Rectangular 24" (61cm) wide x 80" (203cm) long
Motion 1	Electric Height Range 25" - 43" (64cm-109cm) (without pad)
Motion 2	Electric Longitudinal Travel 10" (25cm)
Motion 3	Electric Lateral Tilt $\pm 15^\circ$
Controls	All functions hand control
Weight Capacity	500 lb (227kg)
Product Weight	475 lb (216kg)
Included Features	2" (5cm) Radiolucent Comfort Foam™ table top pad, 4" (10cm) locking casters, Crescent face rest pad (included with integrated headrest top), patient restraint straps (2)
Warranty	3 years parts, 2 years labor
Safety Listings	FDA listed, CE marked, cETLus listed, CB Certificate

OPTIONS *must be ordered with table.*

5" (13cm) casters	Recommended for mobile service providers
Foot Control	All functions control
Non-USA electrical systems	Please inquire

ACCESSORIES *order any time.*

		#
Arm Hammock	Use with Integrated Headrest Top	48751
Carbon Fiber Arm Board (6" wide)	180° Articulation	83575
Fluoro Extender	Polycarbonate	33975
Interventional Supine Pillow System	Contoured pad and support wedge pad	81821
Spine Positioning System II	8 piece system	81819
T-rail Clamp	6" (15cm) long rail	63336



Rectangular Top Table

ACCESSORIES

SPINE POSITIONING SYSTEM II

Radiolucency & adjustability for ideal cervical, thoracic & lumbar visualization. Minimize unwanted movement & reduce procedure time.



ARM HAMMOCK

This unique product will comfortably & easily support your patient's arms when prone. Easily attached to the Integrated Head Rest table top.



SINGLE CARBON FIBER ARM BOARD

Fully radiolucent with a 180° range of motion, the arm board requires no mounting or attachment hardware and simply slides under the table top pad. It can be used on any fluoroscopy table & will support arms and feet in a variety of positioning configurations.



FLURO EXTENDER

Made of radiolucent, polycarbonate material, it's organic shape is conducive to a variety of table placement applications. 30" long x 23.5" wide x 1/4" thick



6" ADJUSTABLE T-RAIL CLAMP

The adjustable T-rail clamp can be positioned along the grooved table top edge. Clamp is also removable.



5" CASTER (OPTIONAL)

Recommended for mobile service providers.



CFPM300 & CFPM301 Imaging Tables

Oakworks Imaging Tables have a large height range helping to create safe patient transfers while allowing doctors to stand comfortably. Our large lifting column is very rigid, ensuring rock solid support for fast imaging and procedures.



Integrated Headrest Table

Motions

- Motion 1 - Height Range 26" - 43" (CFPM300)
- Motion 1 - Height Range 25" - 43" (CFPM301)
- Motion 2 - Trendelenburg Tilt +15/-11°
- Motion 3 - Longitudinal Travel 10" (CFPM301)
- Motion 3 - Lateral Tilt $\pm 15^\circ$ (CFPM300)

Features

- Choice of integrated headrest or rectangular carbon fiber tops with 56" of metal free imaging
- 2" Radiolucent Comfort Foam[®] table top pad
- Warranty is 3 years parts and 2 years labor

SPECIFICATIONS

- Cost Effective 3 Movement Table
- Large Adjustable Height Range 26" - 43" (CFPM300), 25" - 43" (CFPM301)
- 56" Metal Free Imaging Space
- 500 lb Patient Weight Capacity
- Warranty: 3 years parts, 2 years labor

CFPM300 #81803 Integrated #81810 Rectangular **CFPM301** #81804 Integrated #81811 Rectangular

INCLUDED FEATURES	
Carbon Fiber Top 56" Metal free imaging space	Integrated Headrest 22" (56cm) wide x 84" (214cm) long Rectangular 24" (61cm) wide x 80" (203cm) long
CFPM300 MOVEMENTS	
Motion 1	Electric Height Range 26" - 43" (64cm-107cm) (without pad)
Motion 2	Electric Trendelenburg tilt +15°/-11°
Motion 3	Electric Lateral tilt ±15°
CFPM301 MOVEMENTS	
Motion 1	Electric Height Range 25" - 43" (64-109cm) (without pad)
Motion 2	Electric Trendelenburg tilt +15°/-11°
Motion 3	Electric Longitudinal travel 10" (25cm)
Controls	All functions hand control
Weight Capacity	500 lb (227kg)
Product Weight	475 lb (216kg)
Included Features	2" (5cm) Radiolucent Comfort Foam™ table top pad, 4" (10cm) locking casters, Crescent face rest pad (included with integrated headrest top), patient restraint straps (2)
Warranty	3 years parts, 2 years labor
Safety Listings	FDA listed, CE marked, cETLus listed, CB Certificate

OPTIONS <i>must be ordered with table.</i>	
5" (13cm) casters	Upgrade from the standard 4" (10cm)
Foot Control	All functions control
Non-USA electrical systems	Please inquire

ACCESSORIES <i>order any time.</i>		#
Arm Hammock	Use with Integrated Headrest Top	48751
Carbon Fiber Arm Board (6" wide)	180° Articulation	83575
Fluoro Extender	Polycarbonate	33975
Interventional Supine Pillow System	Contoured pad and support wedge pad	81821
Spine Positioning System II	8 piece system	81819
T-rail Clamp	6" (15cm) long rail	63336



Rectangular Top Table

ACCESSORIES



Radiolucency & adjustability for ideal cervical, thoracic & lumbar visualization. Minimize unwanted movement & reduce procedure time.

ARM HAMMOCK

This unique product will comfortably & easily support your patient's arms when prone. Easily attached to the Integrated Head Rest table top.



SINGLE CARBON FIBER ARM BOARD

Fully radiolucent with a 180° range of motion, the arm board requires no mounting or attachment hardware and simply slides under the table top pad. It can be used on any fluoroscopy table & will support arms and feet in a variety of positioning configurations.



FLUORO EXTENDER

Made of radiolucent, polycarbonate material, it's organic shape is conducive to a variety of table placement applications. 30" long x 23.5" wide x 1/4" thick



6" ADJUSTABLE T-RAIL CLAMP

The adjustable T-rail clamp can be positioned along the grooved table top edge. Clamp is also removable.



5" CASTER (OPTIONAL)

Recommended for mobile service providers.



CFPMB301

750 lb. Rated Bariatric Imaging Table

Oakworks large lifting column is very rigid, ensuring rock solid support for patients up to 750lbs. The 18" of vertical travel helps with patient transfers.



Rectangular top 24" x 80"

Motions

- Motion 1 - Height Range 26" - 44"
- Motion 2 - Trendelenburg Tilt +15/-11°
- Motion 3 - Longitudinal Travel 10"

Features

- Large 24" wide x 80' long carbon fiber top with 52.5" metal free imaging space and a wide range of motions
- 2" Radiolucent Comfort Foam[®] table top pad
- Warranty is 3 years parts and 2 years labor

SPECIFICATIONS

- Cost Effective 3 Movement Table
- 750 lb Patient Weight Capacity
- Large Adjustable Height Range 26" - 44"
- 52.5" Metal Free Imaging Space
- Warranty: 3 years parts, 2 years labor

CFPMB301 #81812 Rectangular

INCLUDED FEATURES	
Carbon Fiber Top 52.5" (133cm) Metal free imaging space	Rectangular 24" (61cm) wide x 80" (203cm) long
Motion 1	Electric Height Range 26" - 44" (66cm-111cm) (without pad)
Motion 2	Electric Trendelenburg tilt +15°/-11°
Motion 3	Electric Longitudinal travel 10" (25cm)
Controls	Multi-function hand control
Weight Capacity	750 lb (340kg)
Product Weight	475 lb (216kg)
Included Features	2" (5cm) Radiolucent Comfort Foam™ table top pad, 5" (13cm) locking casters, patient restraint straps (2)
Warranty	3 years parts, 2 years labor
Safety Listings	FDA listed, CE marked, cETLus listed, CB Certificate

OPTIONS <i>must be ordered with table.</i>	
Foot Control (CFPMB301)	All functions
Non-USA electrical systems	Please inquire

ACCESSORIES <i>order any time.</i>		#
Carbon Fiber Arm Board (6" wide)	180° Articulation	83575
Fluoro Extender	Polycarbonate	33975
Interventional Supine Pillow System	Contoured pad and support wedge pad	81821
Spine Positioning System II	8 piece system	81819
T-rail Clamp	6" (15cm) long rail	71679

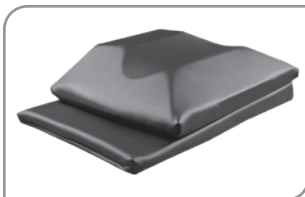

INTERVENTIONAL SUPINE PILLOW SYSTEM

Primarily designed to facilitate cervical transforaminal injections, but useful for other antero-lateral procedures such as facet injections, medial branch blocks, stellate ganglion blocks, scalene injections, brachial plexus blocks and discography.



Rectangular Top Table

ACCESSORIES

SPINE POSITIONING SYSTEM II

Radiolucency & adjustability for ideal cervical, thoracic & lumbar visualization. Minimize unwanted movement & reduce procedure time.



SINGLE CARBON FIBER ARM BOARD

Fully radiolucent with a 180° range of motion, the arm board requires no mounting or attachment hardware and simply slides under the table top pad. It can be used on any fluoroscopy table & will support arms and feet in a variety of positioning configurations.



FLURO EXTENDER

Made of radiolucent, polycarbonate material, it's organic shape is conducive to a variety of table placement applications. 30" long x 23.5" wide x 1/4" thick



6" ADJUSTABLE T-RAIL CLAMP

The adjustable T-rail clamp can be positioned along the grooved table top edge. Clamp is also removable.





CFPM200 & CFPM201 Imaging Tables

Oakworks Imaging Tables have a large height range helping to create safe patient transfers while allowing doctors to stand comfortably. Our large lifting column is very rigid, ensuring rock solid support for fast imaging and procedures.



CFPM201 Integrated Headrest Table

Motions

- Motion 1 - Height Range 25" - 42" (CFPM201)
- Motion 1 - Height Range 25" - 43" (CFPM200)
- Motion 2 - Lateral Tilt $\pm 15^\circ$ (CFPM200)
- Motion 2 - Trendelenburg Tilt $+15^\circ/-11^\circ$ (CFPM201)

Features

- Choice of integrated headrest or rectangular carbon fiber tops with 56" of metal free imaging
- 2" Radiolucent Comfort Foam[®] table top pad
- Warranty is 3 years parts and 2 years labor

SPECIFICATIONS

- Large Adjustable Height Range 25"-43" (CFPM200), 25"- 42" (CFPM201)
- 56" Metal Free Imaging Space
- Cost Effective 2 Movement Table Models
- 500 lb Patient Weight Capacity
- Warranty: 3 years parts, 2 years labor

CFPM200 #84522 Integrated #84524 Rectangular **CFPM201** #84526 Integrated #84528 Rectangular

INCLUDED FEATURES	
Carbon Fiber Top	Integrated Headrest 22" (56cm) wide x 84" (214cm) long
56" Metal free imaging space	Rectangular 24" (61cm) wide x 80" (203cm) long
CFPM200 MOVEMENTS	
Motion 1	Electric Height Range 25" - 43" (64cm-109cm) (without pad)
Motion 2	Electric Lateral tilt $\pm 15^\circ$
CFPM201 MOVEMENTS	
Motion 1	Electric Height Range 25" - 42" (64-107cm) (without pad)
Motion 2	Electric Trendelenburg tilt $+15^\circ/-12^\circ$
Controls	All functions hand control
Weight Capacity	500 lb (227 kg)
Product Weight	475 lb (216 kg)
Included Features	2" (5cm) Radiolucent Comfort Foam™ table top pad, 4" (10cm) locking casters, Crescent face rest pad (included with integrated headrest top), patient restraint straps (2)
Warranty	3 years parts, 2 years labor
Safety Listings	FDA listed, CE marked, cETLus listed, CB Certificate

OPTIONS <i>must be ordered with table.</i>	
5" (13cm) casters	Recommended for mobile service providers
Foot Control (CFPM200)	All functions control
Foot Control (CFPM201)	All functions control
Non-USA electrical systems	Please inquire

ACCESSORIES <i>order any time.</i>		#
Arm Hammock	Use with Integrated Headrest Top	48751
Carbon Fiber Arm Board (6" wide)	180° Articulation	83575
Fluoro Extender	Polycarbonate	33975
Interventional Supine Pillow System	Contoured pad and support wedge pad	81821
Spine Positioning System II	8 piece system	81819
T-rail Clamp	6" (15cm) long rail	63336



CFPM200 Rectangular Top Table

ACCESSORIES

SPINE POSITIONING SYSTEM II

Radiolucency & adjustability for ideal cervical, thoracic & lumbar visualization. Minimize unwanted movement & reduce procedure time.



ARM HAMMOCK

This unique product will comfortably & easily support your patient's arms when prone. Easily attached to the Integrated Head Rest table top.



SINGLE CARBON FIBER ARM BOARD

Fully radiolucent with a 180° range of motion, the arm board requires no mounting or attachment hardware and simply slides under the table top pad. It can be used on any fluoroscopy table & will support arms and feet in a variety of positioning configurations.



FLURO EXTENDER

Made of radiolucent, polycarbonate material, it's organic shape is conducive to a variety of table placement applications. 30" long x 23.5" wide x 1/4" thick



6" ADJUSTABLE T-RAIL CLAMP

The adjustable T-rail clamp can be positioned along the grooved table top edge. Clamp is also removable.



5" CASTER (OPTIONAL)

Recommended for mobile service providers.



CFPM100 Imaging Table



Integrated Headrest Table

Oakworks Imaging Tables have a large height range helping to create safe patient transfers while allowing doctors to stand comfortably. Our large lifting column is very rigid, ensuring rock solid support for fast imaging and procedures. Available with an integrated headrest or rectangle top.

Motion & Features

- Motion 1 - Height Range 22" - 40" - our lowest height range table
- Choice of integrated headrest or rectangular carbon fiber tops with 56" of metal free imaging
- 500 lb. patient weight capacity
- Warranty is 3 years parts and 2 years labor

SPECIFICATIONS

- Our lowest height range table 22" - 40"
- 500 lb Patient Weight Capacity
- Warranty: 3 years parts, 2 years labor

CFPM100 #81805 Integrated Headrest Top
#81813 Rectangular Top

INCLUDED FEATURES	
Carbon Fiber Top 56" (133cm) Metal free imaging space	Integrated Headrest 22" x 84" (56cm x 214cm) Rectangular 24" x 80" (61cm x 203cm)
Motion I	Electric 22" - 40" (56-102cm) Height Range w/o pad
Foot Control	Controls height range
Weight Capacity	500 lb (227kg)
Product Weight	343 lb (216kg)
Included Features	2" (5cm) Radiolucent Comfort Foam™ table top pad, 4" (10cm) locking casters, crescent face rest pad (included with integrated headrest top), patient restraint straps (2)
Warranty	3 years parts, 2 years labor
Safety Listings	FDA listed, CE marked, cETLus listed, CB Certificate

OPTIONS <i>must be ordered with table.</i>	
5" (13cm) casters	Upgrade from the standard 4" (10cm)
Non-USA electrical systems	Please inquire

ACCESSORIES <i>order any time.</i>		#
Arm Hammock	Use with Integrated Headrest Top	48751
Carbon Fiber Arm Board (6" wide)	180° Articulation	83575
Fluoro Extender	Polycarbonate	33975
Interventional Supine Pillow System	Contoured pad and support wedge pad	81821
Spine Positioning System II	8 piece system	81819
T-rail Clamp	6" (15cm) long rail	63336

INTERVENTIONAL SUPINE PILLOW SYSTEM

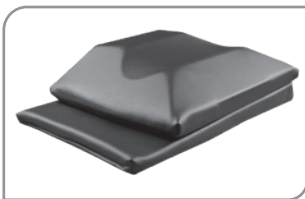

Primarily designed to facilitate cervical transforaminal injections, but useful for other antero-lateral procedures such as facet injections, medial branch blocks, stellate ganglion blocks, scalene injections, brachial plexus blocks and discography.



Rectangular Top Table

ACCESSORIES

SPINE POSITIONING SYSTEM II

Radiolucency & adjustability for ideal cervical, thoracic & lumbar visualization. Minimize unwanted movement & reduce procedure time.



ARM HAMMOCK

This unique product will comfortably & easily support your patient's arms when prone. Easily attached to the Integrated Head Rest table top.



SINGLE CARBON FIBER ARM BOARD

Fully radiolucent with a 180° range of motion, the arm board requires no mounting or attachment hardware and simply slides under the table top pad. It can be used on any fluoroscopy table & will support arms and feet in a variety of positioning configurations.



FLUORO EXTENDER

Made of radiolucent, polycarbonate material, it's organic shape is conducive to a variety of table placement applications. 30" long x 23.5" wide x 1/4" thick



6" ADJUSTABLE T-RAIL CLAMP

The adjustable T-rail clamp can be positioned along the grooved table top edge. Clamp is also removable.



5" CASTER (OPTIONAL)

Recommended for mobile service providers.



DTPM300 Imaging Table

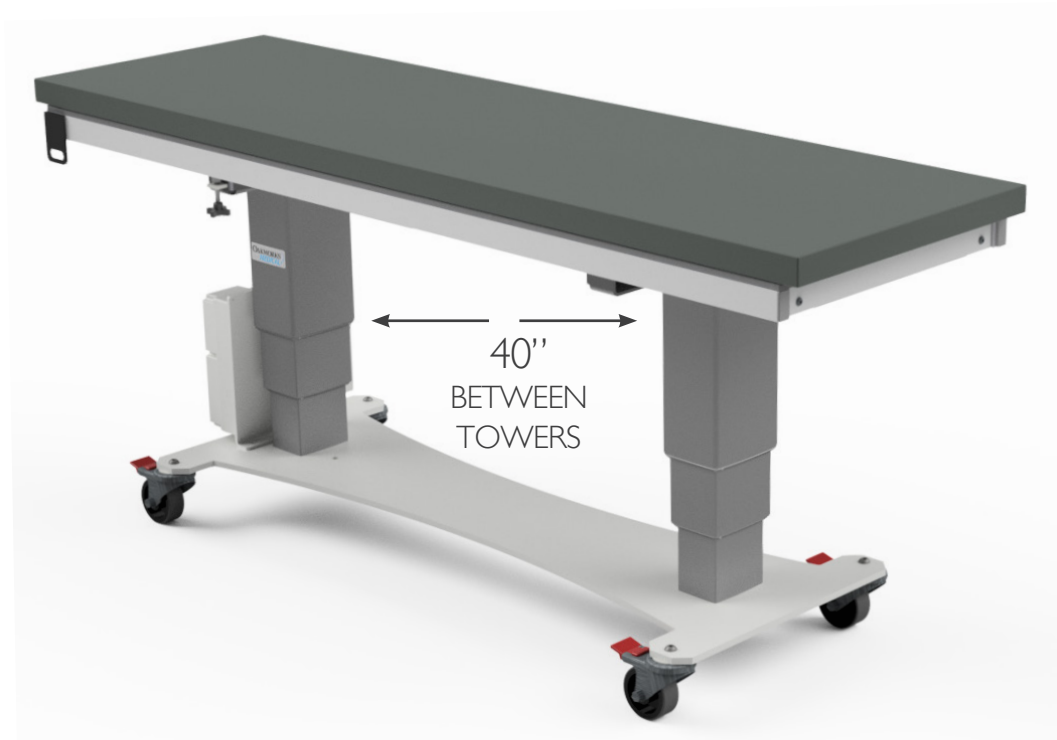

The DTPM300 is a 3 motion table at a great price point. The two tower design with manual longitudinal travel of 23" allows imaging in cervical, lumbar and thoracic areas.

Motions

- Motion 1 - Height Range 24" - 40"
- Motion 2 - Trendelenburg Tilt $\pm 14^\circ$
- Motion 3 - Longitudinal Travel 23"

Features

- Large 24" wide x 78" long Radiolucent Polycarbonate top
- 2" Comfort Foam[®] table top pad
- Warranty is 3 years parts and 2 years labor

SPECIFICATIONS

ACCESSORIES

- Cost Effective 3 Motion Design
- Stable 2 Tower Lift Design
- 40" Open Space Between Towers
- 23" Manual Longitudinal Travel
- Warranty: 3 years parts, 2 years labor

DTPM300 #81806

INCLUDED FEATURES	
Polycarbonate Top with non-scattering aluminum frame	Rectangular 24" (61cm) wide x 78" (198cm) long Imaging area 20" wide x 74" long (50cm x 188cm)
Motion 1	Electric Height Range 24" - 40" (61-101cm) w/o pad
Motion 2	Electric Trendelenburg tilt +14°/-14°
Motion 3	Manual Longitudinal travel 23" (58cm)
Controls	Foot control (height) & hand control (height & trendelenburg)
Weight Capacity	450 lb (205kg)
Product Weight	390 lb (177kg)
Included Features	2" (3cm) Radiolucent Comfort Foam™ table top pad, 4" (10cm) locking casters, patient restraint straps (2)
Warranty	3 years parts, 2 years labor
Safety Listings	FDA listed, cETLus listed, CB Certificate

OPTIONAL TABLE CONFIGURATIONS	TABLE #
With Fixed T-rail (2, 1 on each side)	78" long (198cm) 82013
Non-USA electrical systems	Please inquire --

ACCESSORIES <i>order any time.</i>	#
Carbon Fiber Arm Board (6" wide)	180° Articulation 83575
Fluoro Extender	Polycarbonate 33975
Interventional Supine Pillow System	Contoured pad and support wedge pad 81821
Spine Positioning System II	8 piece system 81819

SPINE POSITIONING SYSTEM II

Radiolucency & adjustability for ideal cervical, thoracic & lumbar visualization. Minimize unwanted movement & reduce procedure time.



SINGLE CARBON FIBER ARM BOARD

Fully radiolucent with a 180° range of motion, the arm board requires no mounting or attachment hardware and simply slides under the table top pad. Will support arms and feet in a variety of positioning configurations.



FLUORO EXTENDER

Made of radiolucent, polycarbonate material, it's organic shape is conducive to a variety of table placement applications. 30" long x 23.5" wide x 1/4" thick



INTERVENTIONAL SUPINE PILLOW SYSTEM

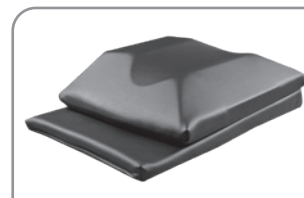

Primarily designed to facilitate cervical transforaminal injections, but useful for other antero-lateral procedures such as facet injections, medial branch blocks, stellate ganglion blocks, scalene injections, brachial plexus blocks and discography.

PATIENT RESTRAINT STRAP



The Patient Restraint Strap helps eliminate unwanted patient movement and injury during surgical procedures. The strap is easily adjusted to accommodate a variety of patient sizes.

- Easily adjusted and repositioned with hook & loop fasteners
- Durable radiolucent material





CFUR301 & CFUR401 Urology Imaging Tables



(Shown with patient transfer extension and lateral extensions)

Motions

- Motion 1 - Height Range 18"
- Motion 2 - Trendelenburg Tilt +15/-11°
- Motion 3 - Longitudinal Travel 10"
- Motion 4 - Lateral Travel 8" (CFUR401 ONLY)

Features

- Carbon fiber top with 19"W x 24"L imaging area
- Comes with Patient Transfer Extension and 2 adjustable lateral extensions
- Warranty is 3 years parts and 2 years labor

SPECIFICATIONS

- Large lifting column creates very stable platform
- 3 and 4 motion models
- 500 lb patient weight capacity
- Warranty: 3 years parts, 2 years labor

CFUR301 #83868

CFUR401 #83867

INCLUDED FEATURES	
Carbon Fiber Top	23" W x 47" L Total surface area 19" W x 25" L Metal free imaging space
CFUR301 MOVEMENTS	
Motion 1	Electric Height Range 26" - 44" (66-111cm) w/o pad
Motion 2	Electric Trendelenburg tilt +15°/-11°
Motion 3	Electric Longitudinal travel 10" (25cm)
CFUR401 MOVEMENTS	
Motion 1	Electric Height Range 26" - 44" (67-114cm) w/o pad
Motion 2	Electric Trendelenburg tilt +15°/-11°
Motion 3	Electric Longitudinal travel 10" (25cm)
Motion 4	Electric Lateral travel 8" (20cm)
Controls	Multi-function hand control + foot control
Weight Capacity	500 lb (227kg) Each Extension: 200 lb (91kg)
Product Weight	CFUR301 - 568 lb (258kg) CFUR401 - 590 lb (268kg)
Lateral Extension	(2) 5" x 24" (12cm x 61cm)
Patient Transfer Extension	(1) 23" x 28" (58cm x 71cm) (Radiolucent)
Included Features	2" (5cm) Radiolucent Comfort Foam™ table top pad, 4" (10cm) locking casters, Digital angle gauge, patient restraint straps (2), US standard full length T-rails on each side
Warranty	3 years parts, 2 years labor
Safety Listings	FDA listed, CE marked, cETLus listed, CB Certificate

OPTIONS must be ordered with table.

Non-USA electrical systems	Please inquire
----------------------------	----------------

ACCESSORIES order any time.

Urology Accessory Package	SchureMed Platinum Stirrups, SpringLoc Rail Clamp, Trapper System, Stirrup Transport and Storage Dolly
Protective Drape	Clear PVC - attaches to T-rail

ACCESSORY PACKAGE

Made in USA

FDA Listed

High quality accessories



GREAT WHITE PLATINUM STIRRUPS

600 LBS Patient Weight Limit
+75°, -30° Also externally rotates out 20°



URO-TRAPPER SYSTEM

Contains fluids during hysteroscopy, cystoscopy, urologic and oncologic surgical procedures



STIRRUP DOLLY

Stirrups and table clamps can be stored in one place



FH58-1901

CFLU401 Lithotripsy/Urology Table

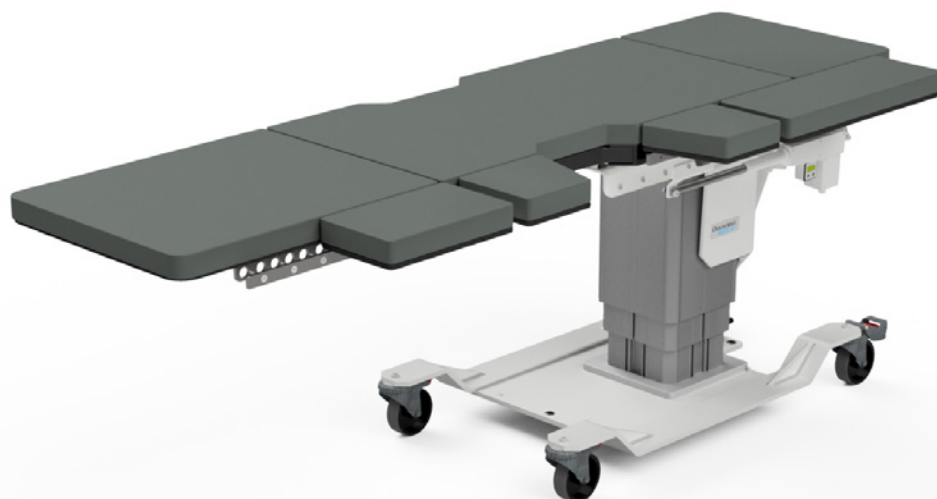

(Shown with optional
knee crutches)

Unique design with moveable panels permits left or right side lithotripsy procedures while offering large support surfaces where needed. Panels are attached to t-rails, allowing flexible positioning along the length of the table. Easily converted for urology.

Motions

- Motion 1 - Height Range 27" - 45"
- Motion 2 - Trendelenburg Tilt +15/-11°
- Motion 3 - Longitudinal Travel 10"
- Motion 4 - Lateral Travel 8"

Features

- Slow speed longitudinal, lateral movement for precise targeting
- 500 lb. weight rating
- Warranty is 3 years parts and 2 years labor

SPECIFICATIONS

FEATURES

- Slow speed longitudinal, lateral movement for precise targeting
- Designed to work with most portable lithotripters & C-Arms
- 500 lb weight rating
- Left & right Lithotripter access
- Rugged design perfect for mobile or stationary use

CFLU40I #82014

INCLUDED FEATURES	
Carbon Fiber Top	23" W x 47" L Total surface area 19" W x 24" L Metal free imaging space
Motion 1	Electric Height Range 27" - 45" (69-114cm) w/o pad
Motion 2	Electric Trendelenburg tilt +15°/-11°
Motion 3	Electric Longitudinal travel 10" (25cm)
Motion 4	Electric Lateral travel 8" (20cm)
Controls	All functions hand control + foot control
Weight Capacity	500 lb (227kg) Each Extension: 200 lb (91kg)
Product Weight	618 lb (280kg)
Lateral Extension	(1) Lateral Extension 8.5" x 24" (22cm x 60cm) (1) Lateral Extension 8.5" x 14" (22cm x 36cm) (2) Angled Lateral Extensions 8.5" x 10" (22cm x 25cm)
Patient Transfer Extension	23" x 28" (58cm x 71cm) (Radiolucent)
Short End Extension	23" x 16" (58cm x 40cm)
Included Features	2" (5cm) Radiolucent Comfort Foam™ table top pad, 5" (13cm) locking casters, Digital angle gauge, patient restraint straps (2), US standard full length T-rails on each side, Urology bag hoop
Warranty	3 years parts, 2 years labor
Safety Listings	FDA listed, CE marked, cETLus listed, CB Certificate

OPTIONS <i>must be ordered with table.</i>	
Non-USA electrical systems	Please inquire

ACCESSORIES <i>order any time. See accessories on pages 34-39.</i>		#
Protective Drape	Clear PVC - attaches to T-rail	69390

PATIENT TRANSFER EXTENSION

Easily removed and installed, radiolucent with 200lb weight rating on the extension alone



UROLOGY BAG HOOP

Table comes with hoop and clamps to t-rails. (bags not included)



DIGITAL GAUGE

Provides accurate read out of trendelenburg setting



PROTECTIVE CLEAR PVC DRAPE (Accessory)

Helps keep clean up to a minimum. Flexible and transparent design maximizes C-Arm positioning possibilities. Clips to T-rail.



POSITIONING ACCESSORIES

Please inquire regarding availability of accessories.



SPINE POSITIONING SYSTEM II

An integral component of the pain management suite

- **Optimal Imaging**
 High radiolucency & flexibility for ideal cervical, thoracic & lumbar visualization.
- **Enhanced Patient Comfort**
 Minimize unwanted movement & reduce procedure time.
- **Stable Design**
 Large contoured torso pad cradles patient & the strap securely fastens the system to the table.
- **Set up Time Reduced**
 Physician can perform spine procedures in a more efficient & secure manner.



RADIOLUCENT FRAME

Used to support the Torso support & Crescent face rest pad. One cam lock facilitates cervical flexion & extension.



Adequate free space under see through face section for aeration, supplemental O₂, jaw/face contact as necessary; prevents patient overheating, can more easily communicate with the patient without sound muffling.

SPINE POSITIONING SYSTEM II

#81819

FEATURES	
Radiolucent Frame with Face Rest	12" x 32.5" (30 x 84cm)
Crescent Face Rest Pad	12" (30cm) diameter
Contoured Torso Support Pad	6.5" x 23" x 30" (17 x 58 x 76cm)
Contoured Torso Wedge	2" x 22" x 29" (5 x 56 x 74cm)
Large Adjuster Pad	8" x 22" x 2" (20 x 56 x 5cm)
Small Adjuster Pad	7" x 12" x 1.5" (18 x 30 x 4cm)
8" Semi-Round Bolster	6" x 8" x 26" (15 x 20 x 66cm)
Stabilizing Strap	For securing SPS to the table
Carry Case	For storage when not in use
Warranty	Fabric, Frame & Padding - 2 years
Safety Listings	FDA listed, CE marked

- No metal (radiopaque) components are present under the spine- unobstructed visibility of the entire spine from CO-C1 to the coccyx with all imaging angles (AP, oblique & lateral). All radiopaque components are placed proximal to the forehead.
- Adjustment easily made to maximize opening & imaging of the cervico-thoracic junction.
- Torso pad elevation under the chest allows for the shoulders to drop out of the plane of imaging when obtaining a lower cervical and upper thoracic lateral & oblique views.
- Adequate adjuster pads to maximize torso build up for larger frame patients.

THE FOLLOWING SCENARIOS IN FACTITIOUS PATIENTS WILL DEMONSTRATE:

- Various body types using the Spine Positioning System II
- Various fluoroscopic images of these factitious patients that exemplify the value of the SPS II

PATIENT - ALICIA

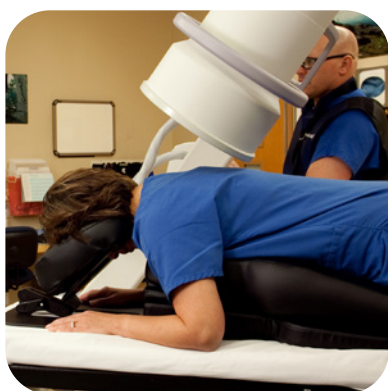

Alicia in the SPS II while obtaining a C3 pillar view



Demonstrates the generous amount of space under the head/face while laying comfortably in the SPS II

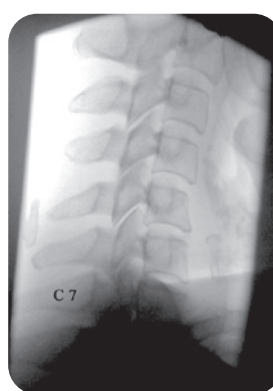

Lateral view of the cervical spine. The C2-3 to C7-T1 interspaces are easily visualized for all posterior approach cervical procedures.

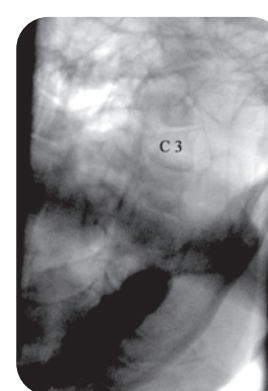

Right C3 and C4 pillar view of Alicia. The target articular pillars are visualized for posterior approach facet/medial branch procedures.

PATIENT - DON



Don in the SPS II while obtaining an oblique image of the lumbar spine

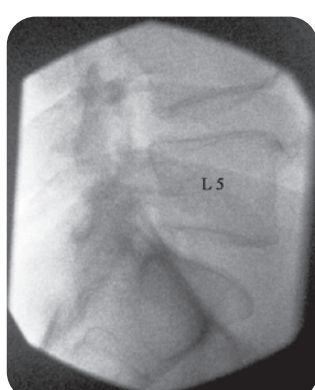

Lateral image of the lumbar spine

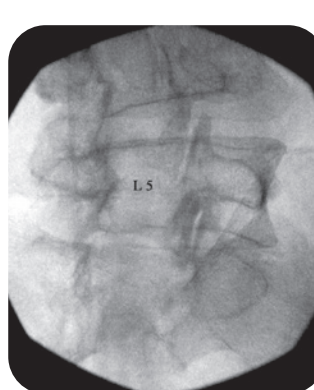

Right oblique image of the lumbar spine

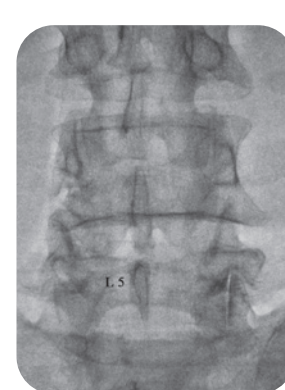

AP image of the lumbar spine

The SPS II was designed with the input of experienced interventional spine physicians under the direction of Paul Dreyfuss, MD. An extensive trial period was undertaken such that various modifications were made to accommodate the precise needs of the interventional pain physician & their patients.



Oakwork's is independently certificated to ISO 13485 Quality management system and regulatory requirement for medical devices. This registration certifies that Oakworks, Inc.'s quality system conforms to these requirements in our state-of-the-art 91,000 square foot factory in New Freedom, Pennsylvania.

Please visit our website, www.oakworksmed.com, to view our complete line of tables and accessories for C-arm Imaging, Pain Management, Ultrasound, Urology, Lithotripsy, Exam & Treatment.



Call For More Information

Oakworks Medical 717.759.3146 www.oakworksmed.com

Regulatory Details

All Oakworks® Imaging Tables (including Urology and Lithotripsy Tables) have the following approvals and regulatory compliance:
FDA listed to regulation #892.1980 – Class 2; CE marked – to CE Declaration of Conformity to Annex I of the EC Directives 90/385/EEC and 93/42/EEC. Authorization to Mark (ATM) to IEC 60601-1-6 3rd Edition, ATM to ANSI/AAMI ES60601-1 3rd Edition, ATM to CAN/CSA-C22.2 No. 60601-1. ETL Test Reports to IEC/EN 60601-1 3rd Edition, IEC/EN 60601-1-2 3rd Edition, IEC/EN 60601-2-32 1st Edition & IEC 62366 1st Edition.